



User Manual

Energy Storage Battery

HZEB-HCT-100



Contents

Foreword	1
• Applicable product	1
• Applicable personnel.....	1
• Legal statement.....	1
• Other statements	1
• Revision history	2
Safety	3
• Safety instruction.....	3
• Personal safety.....	3
• Personnel requirement	3
• Safety warning operation.....	4
Electrical safety.....	4
• Electric safety	4
• ESD safety	4
• Precautions for battery pack	4
Environmental safety.....	5
• Escape way requirements	5
• Moisture protection	5
Safety of machinery.....	5
• General requirement.....	5
• Requirements for heavy object moving.....	5
• Forklift and lifting requirements	5
Specification for live test.....	6
• Live line measurement.....	6
• Use of measuring equipment.....	6
Equipment safety	6
Product disposal	7
□ Product Introduction	7
• Energy storage system introduction	7

• Product function	10
• Product characteristics	10
• Product parameters	7
• Dimension and layout	9
• Product dimension.....	9
• Product layout.....	10
□Product Components Introduction	13
• Battery pack	13
• Cluster control box	13
• Control Panel	13
Application	15
□Transportation requirement	17
• Moving requirement.....	18
• Transportation requirement	18
□Storage requirements	18
• Energy storage system storage (excluding battery pack).....	18
• Battery pack storage.....	18
• Storage environment requirements.....	18
□Installation site requirement	19
• Location requirement	19
• Foundation requirements	21
• Forklift requirements.....	21

• Lifting requirements	22
□ Equipment installation	23
• Preparation before installation	23
• Product installation	24
□ • Rack Mount installation	26
• Battery Pack installation	26
□ Installing Cables	30
• Prepare the cables	
• Install the battery pack cable	27
• Battery Pack Electrical Cables	28
• Battery Pack Communication Cable	28
• Installing External Connection Cables	28
• External electrical cables	28
• External communication cable	28
• Fan power cable	29
System power on	30
• Inspection before powering on	30
• Power on procedures	31
• AC-side power on	31
• DC-side power on	32
□ System power off	32
• Issue a stop work command	33
• Energy storage system power off	33
• AC distribution power off	33
□ System maintenance	33
• Maintenance instruction	33
• Maintenance precautions	34
• Maintenance work	34

● Foreword

This Manual mainly introduces the HZEB-HCT product of Vesol. HZEB-HCT is a lithium iron phosphate DC-side battery storage system suitable for energy storage system. Please read this Manual carefully before installing and using the product, understand the safety information and be familiar with the relevant information, and carefully follow the instructions during the installation process. If you have any questions, please contact Vesol for advice and explanations.

• Applicable product

This Manual applies to the following model:

HZEB-HCT-100

※ In this Manual, unless otherwise specified, any reference to "battery" or "battery pack" refers to the product of that model.

• Applicable personnel

This Manual is only applicable to the professionals who are familiar with local regulations, standards, and electrical systems, have received professional training, and are familiar with the relevant knowledge of the product. Including but not limited to:

Technical support engineer

Installation engineer

Commissioning engineer

Electrical engineer

Maintenance engineer

• Legal statement

The copyright of this Manual belongs to Vesol. Without the prior written authorization of Vesol, no part of this Manual may be extracted, duplicated, translated, annotated or copied in any form or manner.

All rights are reserved by Vesol.

Please note that our company may make modifications to contents of this Manual without prior notice. If any changes are made to its information, we will not notify you separately.

• Other statements

Before transporting, storing, installing, operating, using, or maintaining the equipment, please read this Manual thoroughly. Operate strictly according to the Manual and adhere to all safety precautions indicated on the equipment and in the Manual. In this Manual, "Equipment" refers to the products, software, components, spare parts, and/or services related to this Manual; "the Company" refers to the manufacturer (producer), seller, or service provider of the equipment; and "You" refers to the entity responsible for transporting, storing, installing, operating, using, or maintaining the equipment.

The "Danger," "Warning," and "Caution" items in the Manual do not represent all the safety measures that must be followed. You must also comply with relevant international, national, or regional standards, as well as

industry practices. The Company assumes no liability for any damages resulting from non-compliance with safety operation requirements or violations of design, production, and equipment safety standards.

This equipment should be used in an environment that meets the design specifications. Failure to do so may result in equipment faults, functional abnormalities, or component damage, which will not be covered by the equipment's quality warranty. Additionally, the Company will not be liable for any personal injury, property damage, or other losses that may arise from such conditions.

All activities, including transportation, storage, installation, operation, use, and maintenance, must comply with applicable laws, regulations, standards, and codes.

Reverse engineering, decompiling, disassembling, modifying, implanting, or otherwise studying the internal logic of the equipment, obtaining the software source code, or infringing on intellectual property is prohibited. Additionally, the results of any performance testing of the equipment's software must not be disclosed.

The Company shall not be held responsible for any of the following situations or their consequences:

- Damage to the equipment caused by earthquakes, floods, volcanic eruptions, landslides, lightning strikes, fires, war, armed conflicts, typhoons, hurricanes, tornadoes, extreme weather, or other force majeure events;
- Operating outside the conditions specified in this Manual;
- The installation and usage environment does not meet relevant international, national, or regional standards;
- Installation and use by unqualified personnel;
- Failure to operate according to the instructions and safety warnings provided in the product and documentation;
- Unauthorized disassembly, modification of the product, or alteration of the software code;
- Damage caused by transportation conducted by you or a third party you have authorized;
- Damage resulting from storage conditions that do not meet the requirements specified in the product documentation;
- Materials and tools provided by you that do not meet local laws, regulations, and relevant standards;
- Damage caused by your or a third party's negligence, intentional actions, gross misconduct, improper operation, or reasons not attributable to our company.

•

- **Revision history**

The latest version in the "Revision history" contains updates from all previous versions of this Manual.

V1.0.0.20241217

First issue.

Safety

- **Safety instruction**

Before proceeding with any work, please read all safety instructions carefully and follow them when operating the battery.

Incorrect operation may result in:

- Injury or death of operators or third parties.
- Damage to the system hardware
-

Skills that qualified personnel shall have:

- Training in installation, debugging, and hazard handling of electrical system
- Understanding of this Manual and other related documents
- Understanding of local regulations and directives
-

This Manual may use the following symbols to highlight information, and their meanings are as follows:



Indicates a hazardous situation that, if not avoided, will result in death or serious injury.



Caution: Indicates possible damage or injury.



Indicates potential risks of equipment damage or safety warnings. Failure to avoid these risks may result in equipment damage, data loss, reduced performance, or other unforeseen outcomes.

- **Personal safety**



Do not perform installation, maintenance, or repair operations while the equipment is energized! Ensure that at least two personnel are present on-site during maintenance or repair activities.

- **Personnel requirement**

- Only professional electricians or qualified personnel are authorized to perform operations on this product.
- Operators should be thoroughly familiar with the structure and operating principles of the entire energy storage system.

- Operators should be thoroughly familiar with this Manual.
- Operators should be thoroughly familiar with the relevant standards of the country/region where the project is located.

- **Safety warning operation**

When performing installation, routine maintenance, or repairs on the battery pack, to prevent unauthorized personnel from coming near, making incorrect operations, or causing accidents, please follow these warning procedures:

- Place clear signs in front of and behind the battery pack and at the switches to prevent accidental switching.
- Install warning signs or safety barriers near the operating area.
- After completing maintenance or repairs, always remove the cabinet door key and store it securely.

- **Electrical safety**



Do not perform installation while the equipment is energized. This can cause fire or personal injury.

- **Electric safety**

- Do not touch terminals or conductors connected to the power grid.
- Pay attention to all instructions or safety documentation related to connections with the power grid and adhere to the warning labels on the product.
- Follow the safety precautions listed in this Manual and other related documents for the equipment.
- Perform a preliminary visual inspection of the equipment before operation to check for damage or other hazards.
- Check that all external equipment and circuit connections are secure.
- Ensure the equipment is in a safe condition before operating.

- **ESD safety**

- Avoid unnecessary contact with circuit boards.
- Follow electrostatic discharge protection guidelines, such as wearing anti-static wrist straps.

- **Precautions for battery pack**

- There is a lethal high voltage between the positive and negative terminals of the energy storage battery pack.
- When maintaining the equipment, ensure that the connection between the energy storage inverter and the energy storage battery pack is completely disconnected.

- **Environmental safety**



Do not place the equipment in flammable, explosive, or dusty environments, as this may cause fire or explosion hazards.

- **Escape way requirements**

To ensure that staff can quickly evacuate the scene in case of an accident, please follow the below:

- Do not place flammable or explosive materials around the battery pack.
- Do not block or occupy escape routes with clutter or in any other manner.

- **Moisture protection**

- Do not use the product in environments exceeding the specified humidity levels.

- **Safety of machinery**



When performing work at heights, always wear safety helmets and other protective equipment, and secure yourself to stable structural components to prevent falls. Before installing equipment, ensure it is properly secured to avoid tipping, which could cause injuries or damage to personnel and equipment.

- **General requirement**

- During transportation and installation, any scratches must be promptly repaired. Do not allow scratched areas to remain exposed for extended periods.
- Unauthorized welding, cutting, or any other operations to the equipment are prohibited.
- Use tools correctly and ensure proper handling techniques.
- When working at height, use wooden or insulated ladders; do not use single-step ladders.
- When using a ladder, ensure it is placed on a stable, flat surface, and have someone hold the ladder while you work.

- **Requirements for heavy object moving**

- Prepare for load-bearing before moving heavy objects.
- When multiple people are involved in moving, distribute the load evenly to ensure balanced weight distribution.
- Wear protective gloves, safety shoes, and other safety gear when moving heavy objects.

- **Forklift and lifting requirements**

- When using a forklift, ensure the forks are in the center position before lifting to prevent tipping.
- Before moving, secure the equipment to the forklift with ropes. During movement, assign a dedicated person to supervise.

- Lifting personnel must complete and pass relevant training before being allowed to perform the work.
- Place warning signs and barriers to isolate the lifting area.
- The lifting conditions must meet the operational requirements
- Do not allow personnel to walk underneath during lifting operations.
- During lifting operations, ensure the angle of the lifting cables is less than 90°.

- **Specification for live test**



There is a lethal high voltage between the positive and negative terminals of the energy storage battery pack. Ensure that two people are involved in the operation to maintain safety.

- **Live line measurement**

The equipment contains high voltage, and accidental contact may result in fatal electric shock. Therefore, when performing live line measurements:

- ensure proper protective measures are in place (such as wearing insulated gloves and insulated footwear).

- **Use of measuring equipment**

When conducting electrical measurements, connections, trial runs, and other operations on equipment:

- Select high-quality measuring equipment that matches the range and conditions required for the site requirements.
- Ensure that the measuring equipment is connected and used correctly and according to standards to prevent hazards such as electrical arcs.

- **Equipment safety**



Fencing, walls, or other protective measures must be installed around the equipment. Safety warning signs should be posted to isolate the area, preventing unauthorized personnel from entering or causing accidental operations during equipment operation, thereby avoiding personal injury or property damage.

- The equipment installation and layout must meet the installation protection requirements specified by local standards, including but not limited to. Requirements of Design Code for Electrochemical Energy Storage Station (GB 51048-2014) and Standard for the Installation of Stationary Energy Storage Systems (NFPA 855).
- Before installing, operating, or maintaining the battery, read the relevant instructions and follow the manufacturer's requirements.
- Please use the battery within the specified temperature range.

- If the battery is accidentally exposed to water, do not continue with the installation. Move it to a safe location and arrange for prompt disposal.
- Before installing the battery, check that the battery pack enclosure is free from damage or deformation.

- **Product disposal**



When disposing of the product, do not treat it as regular waste.

- The Company has priority rights for the recycling of discarded batteries.
- For discarded batteries not recycled by the Company, please contact a local authorized recycling organization or manufacturer for disposal and recycling.

Note: This Manual may not cover all possible situations during operation, maintenance, or repair. If you encounter circumstances not explained in the manual, please follow the relevant local regulations and standards and contact Yichun Vesol Manufacture and Trade Co., Ltd. promptly.

- **Product Introduction**

- **Energy storage system introduction**

The energy storage system involves the process of storing energy in a medium or device and then releasing it when needed. The energy storage system includes input and output devices of energy and materials, along with energy conversion and storage devices. Energy storage technologies can be classified into several categories, including physical energy storage, electrochemical energy storage, and electromagnetic energy storage.

The electrochemical energy storage system is a system that uses electrochemical batteries as the storage carrier and employs power conversion systems (PCS) to store and release electrical energy in a cyclic manner. The essence of an electrochemical energy storage system is to convert electrical energy into chemical energy, which is then stored and later released through the mechanism of chemical battery, ultimately converting back into electrical energy to be fed into the power grid. Compared with other energy storage technology routes, the electrochemical energy storage system is characterized by higher energy density, moderate response speed, and wide range of applications, and is easier to mass-produce, install, and operate and maintain, thus having excellent potential for large-scale promotion.

Electrochemical energy storage includes forms such as lithium-ion, sodium-ion, and liquid flow. Among these, lithium-ion technology is the most mature and is currently the widely recognized route in the market.

In an energy storage system, storage battery serves as a critical device for energy storage and plays a key role in adapting to various usage scenarios.

- **Product characteristics**

This product is a DC side energy storage system, which is designed in a simple indoor rack form and has the characteristics of low cost, easy installation, transportation, maintenance and expansion. The system is composed

of lithium iron phosphate battery units with high energy density, low cost and high safety, connected in a certain series and parallel manner, and equipped with an advanced battery management system. It is flexible, reliable and easy to expand and upgrade; in addition, it also has the following functions:

- All-round, multi-level battery warning and protection strategy, high safety
- With complete communication and monitoring functions, long-term continuous and stable operation
- A single stack can support up to 10 clusters in parallel (EMS system is required)

• **Product Parameters**

Model	HZEB-HCT-100
Cell type	LiFePO4
Battery pack configuration	1P112S
Rated power (kWh)	100.35
Capacity (Ah)	280
Rated voltage (VDC)	358.4
Operating voltage (VDC)	313.6~403.2
Charge and discharge rate(C)	0.5
Standard charge and discharge current(A)	100
Maximum charge and discharge current(A)	140
Dimension(mm)	1218*1100*792
Weight(kg)	1360
Protection level	IP20
Charging temperature range (°C)	0~55
Discharge temperature range (°C)	0~55
Cycle life	≥6000 times 25±2°C,80%DOD 0.5C, 80%SOH
Communication	CAN/RS485

Table Product parameter

- **Dimension and layout**

- **Product dimension (mm)**

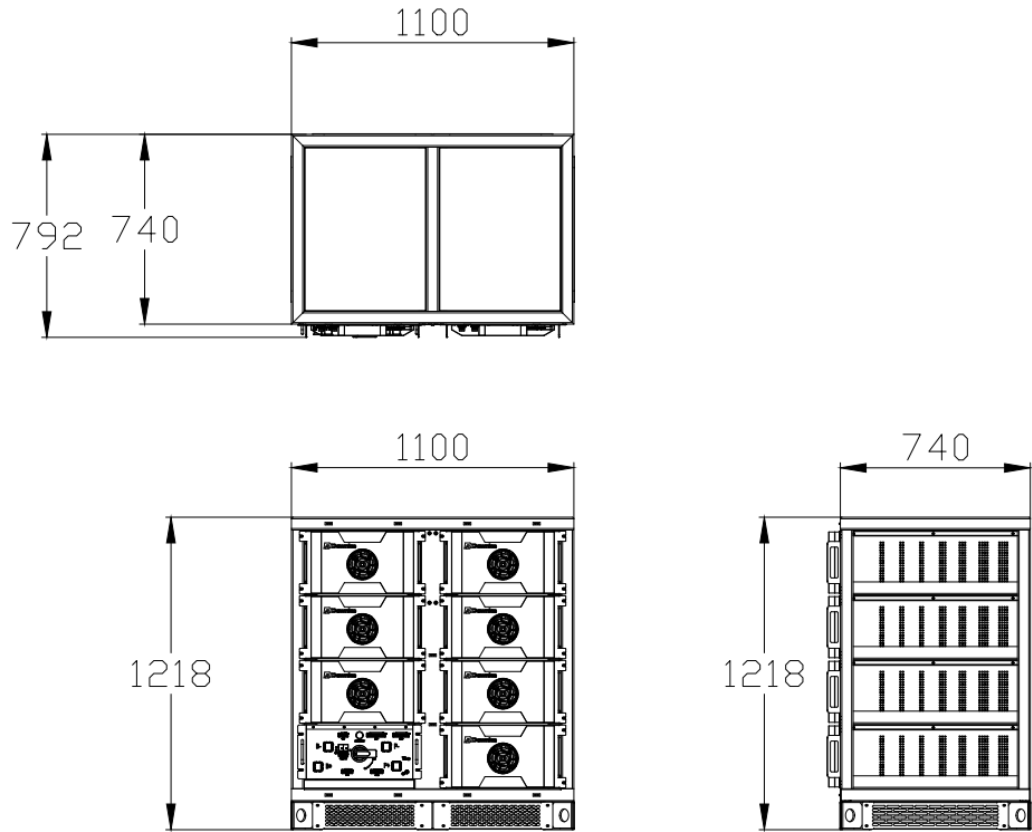

Figure Product dimension

• **Product layout**

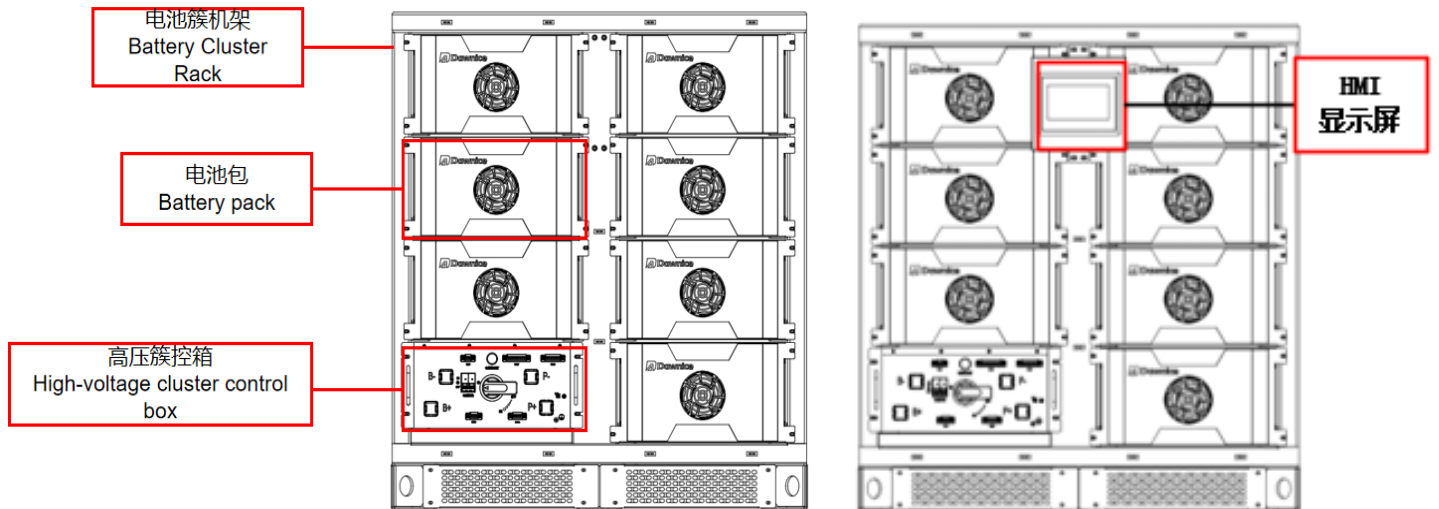

Figure Product layout-external

• **Product components introduction**

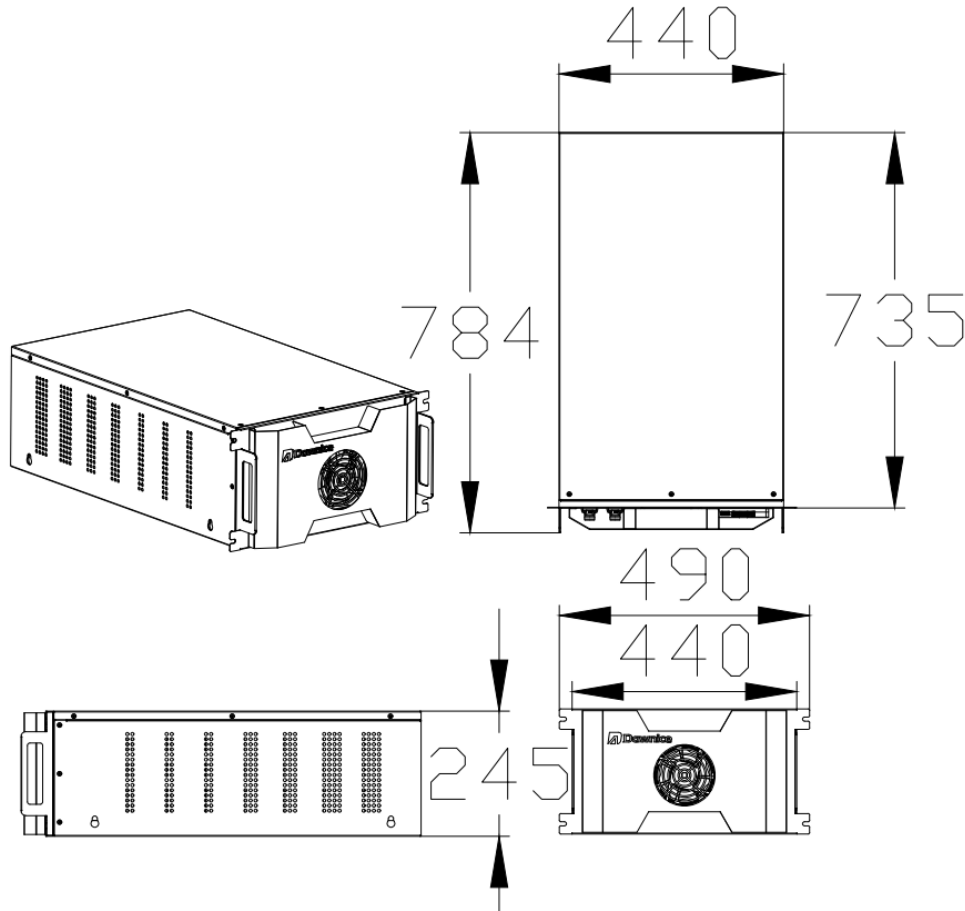
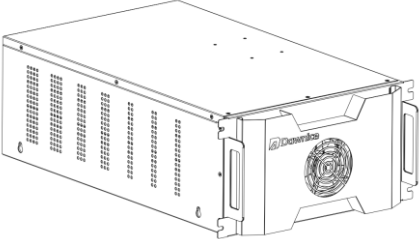

Figure 3-view of battery pack dimensions

• **Technical parameters of battery pack:**

Unit	Model/Description	HZ-PACK-15
	Cell type	LFP280Ah
	Maximum charge rate	0.5C
	Rated charge-discharge rate	0.5C
	Maximum discharge rate	0.5C
	Cell combination method	1P16S
	Nominal capacity	280Ah
	Nominal energy	14.336kWh
	Nominal voltage	51.2V

	Operating voltage range	43.2-57.6V
	Operating temperature range	Discharge: -20°C-55°C;
		Charging: 0°C-55°C

Table Technical parameters of battery pack

• **High-voltage cluster control box**

Figure Dimension of high-voltage cluster control box

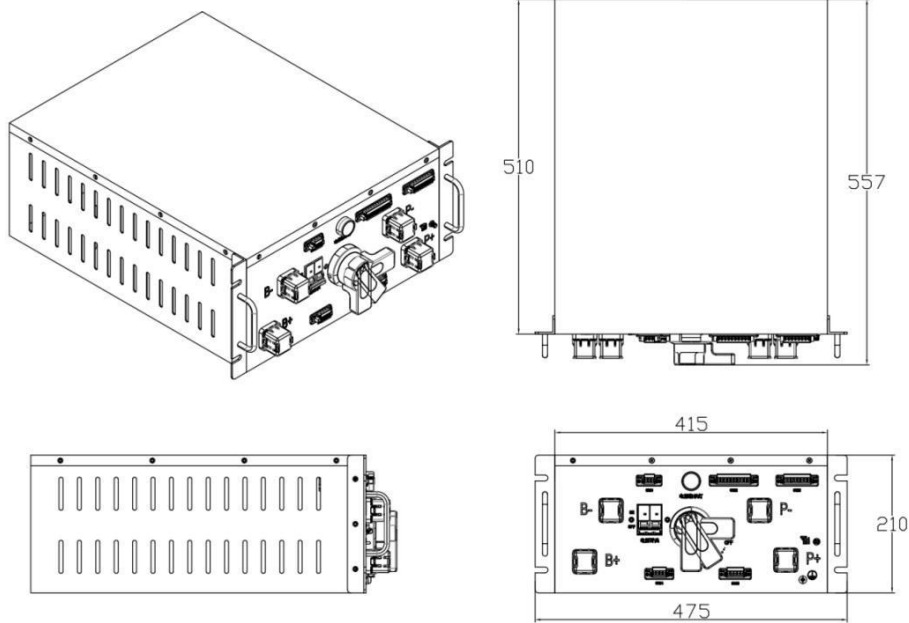

• **Control panel**

Figure Panel of high-voltage cluster control box

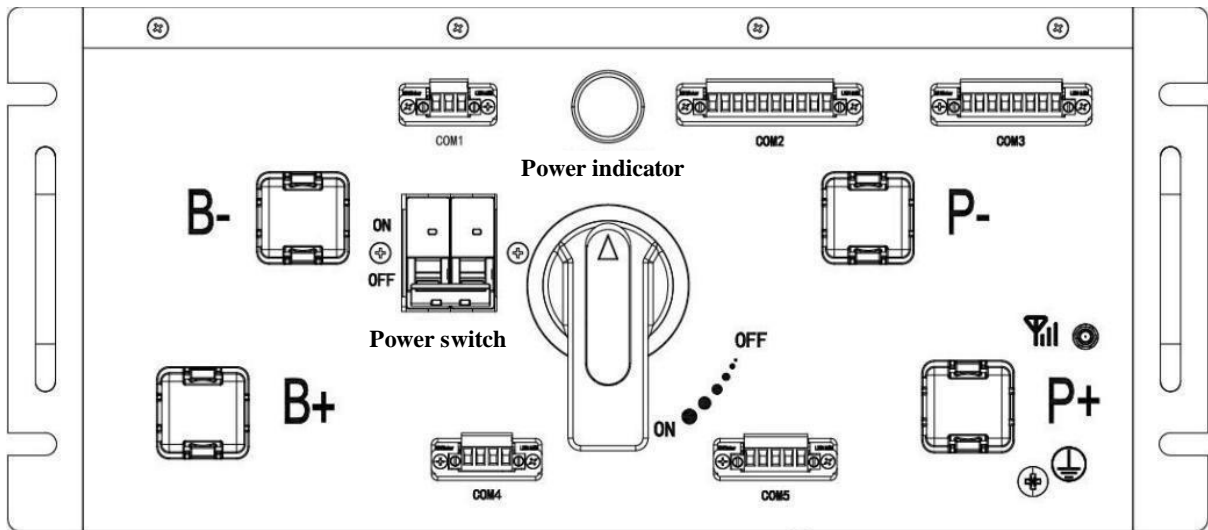

Power input/output interface definition:

Interface Definition	Function Description	Remark
----------------------	----------------------	--------

B+	Battery cluster input positive terminal	Connect to the battery cluster positive terminal, with the interface using a M8 bolt
B-	Battery cluster input negative terminal	Connect to the battery cluster negative terminal, with the interface using a M8 bolt
P+	PCS input positive terminal	Connect to the PCS positive terminal, with the interface using a M8 bolt
P-	PCS input negative terminal	Connect to the PCS negative terminal, with the interface using a M8 bolt

Table: Definition of power interface for high-voltage cluster control box

Definition of communication interface:

No.	I/O	COM Port	Definition	Function Description
1	I	COM1(3P)	AC220V-N	N
2	/		/	/
3	I		AC220V-L	L
1	I/O	COM2(10P)	CAN1R	Terminal resistor
2	I/O		CAN1H	Isolated CAN (Connect to PCS or external device)
3	I/O		CAN1L	
4	I/O		CAN1G	
5	I/O		RS485-A1	Isolated 485 (Connect to PCS or external device)
6	I/O		RS485-B1	
7	I/O		RS485-G1	
8	I/O		RS485-A0	Non-isolated 485 (Connect to display screen or external device)
9	I/O		RS485-B0	
10	I/O		RS485-G0	
1	O	COM3(8P)	GND	Switching value detection, effective short circuit
2	O		SWITCH_IN	
3	/		SW2_IN	Dry contact 2 (0.1 A)
4	I/O		SW2_OUT	
5	I/O		SW1_IN	Dry contact 1 (0.1 A)
6	/		SW1_OUT	
7	O		24V+_OUT	Output 24 V+ (Rated 75 W)
8	O		24V-_OUT	Output 24 V- (Rated 75 W)
1	I/O	COM4(4P)	DEBUG_CANH	Debug CANH
2	I/O		DEBUG_CANL	Debug CANL
3	I		24V+_IN	Input 24 V+
4	I		24V-_IN	Input 24 V-

1	I/O	COM5(5P)	SPI-H	Intranet daisy chain communication H
2	I/O		SPI-L	Intranet daisy chain communication L
3	/		/	/
4	O		FAN+	Fan power output 24 V+
5	O		FAN-	Fan power output 24 V-

Table: Definition of communication interface for high-voltage cluster control box

- Typical application scenario**

Single battery topology:

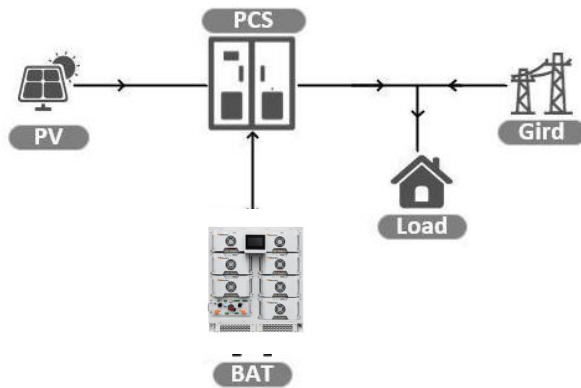

Multiple battery topology:

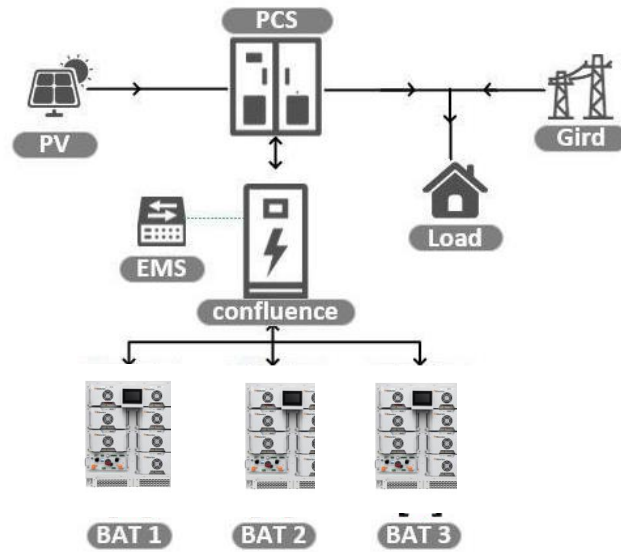

• **Typical application scenarios:**

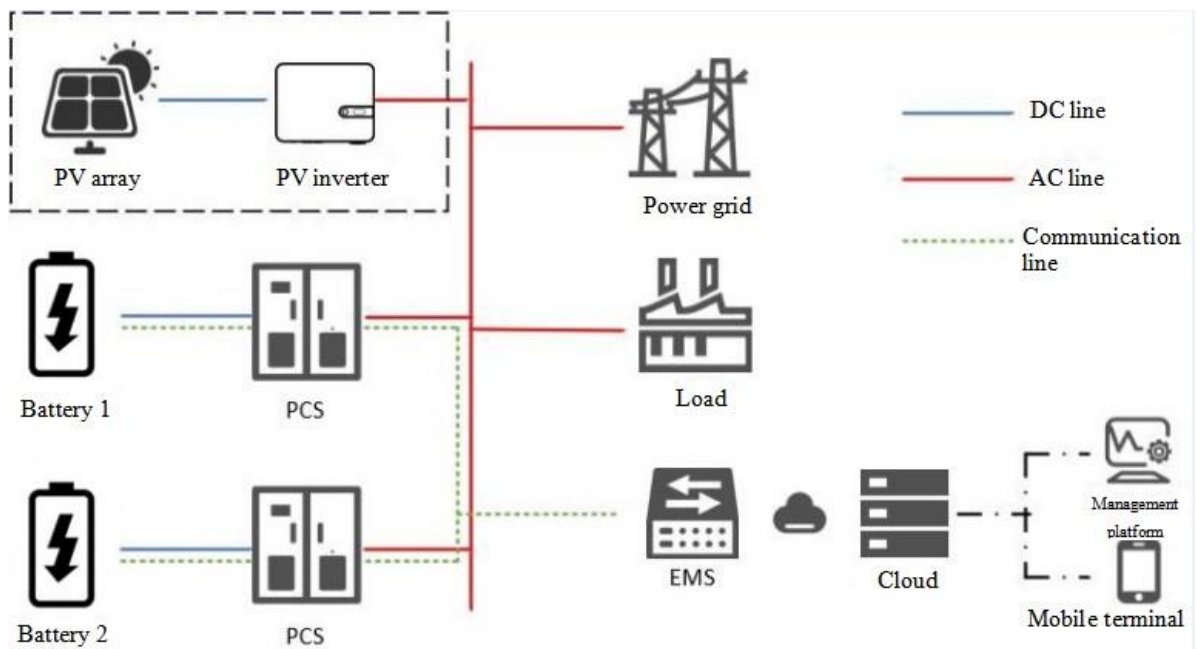

● **Transportation requirement**

• **Moving requirement**



During the moving process, comprehensive safety measures must be implemented. When moving items, handle them gently, avoid dragging or throwing them on rough surfaces.

- When moving heavy objects, be prepared to support the weight properly to avoid injury from being crushed or strained.
- When two or more people are moving heavy objects together, one person should be in charge of directing the process. Everyone should lift or lower the equipment simultaneously and in unison.
- When moving equipment manually, you should wear protective gloves and safety shoes, among other safety gear, to prevent injuries.
- When manually moving equipment, approach the object, squat down, and use the strength of your straightened legs rather than your back to lift it. Lift slowly and steadily, avoiding sudden jerks or twisting of the torso.
- When moving or lifting equipment, hold onto the equipment handles or support the bottom edge, rather than gripping handles attached to installed modules.
- Avoid lifting heavy objects quickly above waist height. Place the object on a workbench or suitable surface at waist level first, adjust your grip, and then lift it.
- When moving heavy objects, apply force evenly and steadily. Move at a consistent, slow speed and position the object carefully to avoid impacts or drops that could scratch the equipment surface or damage components and cables.
- When moving heavy objects, be especially cautious around workbenches, ramps, stairs, and slippery areas. Ensure that doorways are wide enough to accommodate the equipment when moving through them to prevent injury or damage.
- When transporting heavy objects, move your feet rather than twisting your waist. If you need to lift and move the object simultaneously, first point your toes in the direction you intend to move, then proceed with the lift.
- When using a forklift, ensure the forks are positioned in the center to prevent tipping. Before moving, secure the equipment with straps, and assign a person to oversee the operation.
- The placement angle should meet the requirements: with packaging, the tilt angle α should be $\leq 15^\circ$, and after removing the packaging, it should be $\leq 10^\circ$.

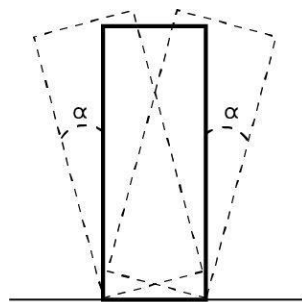

- During the moving and transportation of air conditioners, keep the unit in an upright position at all times. Do not place the air conditioner flat or on its side.

- **Transportation requirement**

- Rough handling during loading and unloading is prohibited, as it may cause battery short circuits, damage (such as leakage or rupture), fire, or explosion.

- During moving, ensure that the battery is transported according to its specified orientation. Do not invert, tilt, drop, expose to mechanical impacts, or subject to rain, snow, or immersion in water.
- Batteries must be transported separately. For cabinets equipped with batteries, transportation with the batteries installed is prohibited. If the cabinet needs to be transported or moved, the batteries must be removed first.
- The battery is certified according to UN38.3 (UN38.3: Section 38.3 of the sixth Revised Edition of the Recommendations on the Transport of Dangerous Goods: Manual of Tests and Criteria) and is classified as a Class 9 hazardous material.
- The transport service provider must have qualifications for handling hazardous materials. The use of open-top vehicles is strictly prohibited.
- The battery can be shipped directly to the site, provided it meets the transportation requirements for vehicles, ships, and other modes of transport.
- The international regulations for the transport of hazardous materials should be complied with, and the regulatory requirements of the origin country, transit countries, and destination country authorities should be met.
- Sea transport or well-maintained highways should be used for shipping; rail and air transport are not supported. During transport, minimize bumps and tilting as much as possible.
- For sea transport, adhere to the requirements of the International Maritime Dangerous Goods Code.
- Before transport, the battery packaging must be checked for completeness and integrity. Ensure there are no signs of odor, leakage, smoke, or fire; otherwise, transport is prohibited.
- The transport packaging must be sturdy. Handle with care during loading, unloading, and transit, and implement moisture protection measures.

● Storage requirements



Due to the characteristics of lithium batteries, storage must adhere to specific battery storage requirements. Failure to do so may result in permanent damage or performance degradation.

- Battery packs should not be stored for extended periods. Long-term storage of lithium batteries can lead to capacity loss, with an irreversible capacity loss of 3% to 10% typically occurring after 12 months at recommended storage temperatures.
1. The battery should be stored in a clean, dry place, and should be protected from dust and moisture. Avoid exposure to rain or standing water.
 2. The environment must be free from corrosive or flammable gases.
 3. The battery should not be stored tilted or inverted.
 4. For equipment other than battery packs that has been stored for two years or more, it must be inspected and tested by a professional before use.

- **Energy storage system storage (excluding battery pack)**

- Avoid removing the packing during long-term storage.
- Avoid stacking storage.
- Store (long-term or temporary) on a flat surface.
- Close the cabinet door tightly.
- Storage environment temperature: -40°C – $+60^{\circ}\text{C}$, relative humidity: 5% RH–90% RH.

- **Battery pack storage**

- Batteries should be stored indoors, away from direct sunlight and rain, in a dry and well-ventilated area. The surroundings should be clean, free from excessive infrared or other radiation, organic solvents, corrosive gases, and conductive metallic dust. Keep them away from heat and ignition sources.

- If a battery shows signs of fault (such as carbonization, leakage, swelling, or water ingress), it must be promptly transferred to a hazardous materials storage area, kept at least 3 m away from flammable materials, and disposed of as soon as possible.

- When storing batteries, place them according to the packaging labels. Do not store them upside down, on their side, or tilted. Ensure stacking complies with the requirements specified on the outer packaging.

- Batteries should be stored separately from other equipment and should be avoided stacking too high. Ensure that the site is equipped with appropriate fire safety measures, such as fire sand and extinguishers.

- After discharging, batteries may experience static power consumption of internal modules and self-discharge, which could lead to damage from over-discharge. Avoid storing batteries in a low-charge state and promptly recharge them. If a battery experiences permanent fault due to lack of recharging beyond the recommended period, the Company will not provide warranty services. Scenarios triggering low-charge storage include but are not limited to:

- Battery power cables or signal lines are not connected
- The battery cannot enter charging mode due to a system fault after discharging in an energy storage system
- The battery cannot enter charging mode due to improper configuration of the energy storage system
- The battery cannot enter charging mode due to prolonged loss of AC power
- The battery cannot enter charging mode due to the control system, PCS (Power Conversion System), or main circuit components not being properly closed or engaged

- **Storage environment requirements**

- Environmental temperature: -30°C – $+50^{\circ}\text{C}$ (excluding battery pack)
- Environmental temperature: 0°C – 30°C (battery pack); It is recommended to store the battery pack in a constant temperature environment of 25°C . Long term storage may affect the performance and service life of the battery.
- Relative humidity: 5% RH–90% RH (recommended around 45% RH).
- Dry, ventilated, and clean.

- Avoid contact with corrosive organic solvents, gases, and other substances.
- Avoid direct sunlight.
- The distance from the heat source should not be less than two meters.
- When storing, it is necessary to disconnect from the external connection. If there is an indicator on the battery pack panel, the indicator should be in the off state.
- Report any overdue storage promptly.
- When shipping batteries, follow the first-in, first-out principle.
- Move batteries gently during transport, and avoid damaging them.

● Installation site requirement

• Location requirement

- This system is only suitable for indoor scenes.
- The installation environment horizontal surface should be elevated above the area historical highest water level and at least 300 mm above the ground. The installation site must not be in a low-lying area.
- The installation site and a 3-meter surrounding area of the energy storage system or energy storage station should be free of vegetation and flammable plants to prevent fires caused by wildfires during high summer temperatures.
- The safety distance between the energy storage system and buildings should comply with local fire safety regulations or standards.
- The safety distances for the energy storage system are as follows: at least 12 m from Class A production buildings, at least 10 m from Class B production buildings, at least 10 m from Class C, D, and E production buildings with a fire resistance rating of Grade I or II, at least 12 m from Class C, D, and E production buildings with a fire resistance rating of Grade III, and at least 12 m from residential buildings. If the exterior walls of adjacent buildings are non-combustible and have no doors, windows, or exposed combustible eaves, the fire safety distance can be reduced by 25% from the previously specified distances.
- If the specified safety distances cannot be met, a fire wall must be installed between the battery equipment room, energy storage room, or energy storage installation area and Class C, D, and E buildings. The fire wall should have a fire resistance rating of at least 3 hours and extend 1 m beyond the outer contours of the energy storage system in terms of length and height. Additionally, the fire wall design should consider space requirements for equipment transportation, installation, and maintenance.
- The energy storage system or energy storage station must be situated in an environment free from explosion or fire risk.
- The site should have convenient transportation access and reliable fire suppression system equipment.

Description 1

- During the installation, commissioning, and operation phases of the energy storage system, the fire safety principle should be prioritized. At least two gas fire extinguishers, such as those using halon, perfluorohexane, or carbon dioxide, should be placed near each unit.
- Please reserve a water fire extinguishing system interface for the energy storage system site.
- Ensure the site meets the immediate space requirements and provides additional space for future expansion based on the full lifecycle needs.

- Choose a place with good ventilation
- The energy storage system should not be installed in areas prone to salt damage or pollution, as it will suffer from corrosion. It is suitable for use in the following or better environments:
 - The energy storage system is suitable for outdoor environments more than 2,000 m from the coast. It is not recommended for use within 500 m–2,000 m of the coast (if needed, confirm with the distributor or our engineers). The system should not be used within 500 m of the coast.
 - 1,500 m–3,000 m away from heavy pollution sources such as smelters, coal mines, and thermal power plants
 - 1,000 m–2,000 m away from moderate pollution sources such as chemical, rubber, and electroplating
 - 500 m–1,000 m away from light pollution sources such as food, leather, heating boilers, slaughterhouses, centralized garbage dumps, and sewage treatment plants

Description 2

If the safety distance at the selected site does not meet relevant national standards, it is advisable to choose a new location. The site should avoid scenarios not recommended by industry standards and regulations, including but not limited to the following areas, regions, and locations:

- Areas with strong vibration, intense noise sources, and significant electromagnetic interference.
- Places with dust, oil smoke, harmful gases, or corrosive gases.
- Places where corrosive, flammable, or explosive materials are produced or stored.
- Places with existing underground facilities.
- Areas with poor geological conditions, such as rubber soil, soft soil layers, or surfaces prone to water accumulation and subsidence.
- Areas beneath water reservoirs, water landscapes, or water intake rooms.

Description 3

- If placement in a potentially water-accumulating area is unavoidable, install barriers, drainage facilities, or elevate the ground.
- Cable trenches should not be used as drainage pathways. Penetrations for cables through walls or floors must be fire-stopped.
- Areas with seismic fault lines or seismic zones with a risk level higher than magnitude 9.
- Areas prone to direct hazards such as mudslides, landslides, quicksand, or sinkholes.
- Within the boundaries of mining subsidence (displacement) zones.
- Within the blast danger zones.
- Areas that could be submerged if a dam or levee were to fail.
- Important sanitary protection zones for water supply sources.
- Historical and cultural heritage protection zones.
- Crowded places, high-rise buildings, and underground structures.
- Intersections of arterial street and heavily trafficked areas.
- **Site selection for flood and drainage control:**
 - For large-scale electrochemical energy storage system (with a power rating of ≥ 100 MW), the site design elevation should be higher than the 1% flood level or the highest historical flood level.

- For medium and small-scale electrochemical energy storage system (with a power rating of <100 MW), the site design elevation should be higher than the 2% flood level or the highest historical flood level.
- If the site design elevation cannot meet the above requirements, choose an alternative site or implement various flood and drainage measures based on different conditions.
- For energy storage stations along rivers, lakes, or coastal areas affected by wind and waves, flood protection facilities should be designed to accommodate a 2% wave height plus an additional 0.5 m for safety.
- When there is significant runoff entering or crossing the site perimeter, it is advisable to install ditches or drainage (cut-off) channels to manage surface water drainage systematically.

- **Fence against illegal entry:**

It is recommended to use solid walls or fences for isolation and protection around the energy storage area. The fence should have a lockable gate, and its height should be greater than 2.2 m. Firewalls may replace part or all

of the fencing, depending on the design considerations.

- **Foundation requirements**

- The energy storage system must be installed on a concrete or other non-combustible surface. Ensure that the installation plane is level, stable, and even, with sufficient load-bearing capacity. Installation on surfaces with depressions or inclines is prohibited.
- The equipment foundation should be designed based on a load-bearing capacity of 2,750 kg per unit. If the foundation load-bearing capacity is insufficient, it must be reassessed.
- The bottom of the equipment foundation pit must be thoroughly compacted and levelled.
- After excavation of the equipment foundation, avoid water exposure and disturbance. If water exposure occurs, continue excavation and replace the disturbed material.
- The horizontal deviation between the equipment foundation and the equipment contact surface must not exceed 3 mm.
- The foundation must be higher than the local historical highest water level and at least 300 mm above the ground.
- Construct drainage facilities based on local geology and municipal drainage requirements to prevent water accumulation at the equipment foundation. The equipment foundation must meet the drainage requirements for the area's historical maximum rainfall, and the discharged water should be treated in accordance with local laws and regulations.
- When constructing the equipment foundation, consider the routing of energy storage system cables by reserving trenches or entry holes.
- The reserved holes in the equipment foundation and the entry holes at the bottom of the equipment should be properly sealed.
- Users must verify the foundation design parameters of the energy storage system based on the project's installation environment, geology, and seismic requirements.

- **Forklift requirements**

- Do not move the energy storage system after the battery pack harness has been installed.
- If using a forklift for cabinet installation, the forklift load capacity must be ≥ 3 t.
- If using a forklift for battery pack installation and maintenance, the forklift load capacity must be ≥ 1 t.

- Recommended fork length: 1,300 mm–1,500 mm, width: 80 mm–160 mm, and thickness: 25 mm–80 mm.
- Forklift lifting height requirement: when the foundation height is ≤ 0.3 m, the lifting height should be ≥ 2 m; when the foundation height is greater than 0.3 m, the lifting height increases accordingly.

- **Lifting requirements**

Personnel involved in lifting operations must receive relevant training and be certified as competent before they can perform the tasks.

- The lifting area must be marked with temporary warning signs or fenced off for isolation.
- The foundation for lifting operations must meet the load-bearing requirements for the crane.
- Before lifting, ensure that the crane and lifting ropes meet the load-bearing requirements.
- Before lifting, ensure that the lifting tools are securely fixed to fixed structures or walls that meet the load-bearing standards.
- During lifting operations, do not walk under the crane boom or the lifted load.
- During lifting operations, do not drag wire ropes or lifting equipment, and avoid using hard objects for

impact.

- During lifting, ensure that the angle between the two cables does not exceed 90° .
- When installing or dismantling lifting equipment, avoid dragging it across the cabinet to prevent scratches.
- Do not perform lifting or moving operations after the battery pack has been installed in the energy storage system.

- **Lifting precautions:**

Before lifting:

- Crane lifting capacity ≥ 3 t, working radius ≥ 2 m. If the on-site working conditions do not meet requirements, consult a professional for assessment.
- Personnel involved in lifting operations must receive relevant training and be certified as competent before they can perform the tasks.
- Lifting tools must be inspected and complete before use.
- Ensure that lifting tools are securely fixed to load-bearing structures or walls.
- When using outdoors, it is recommended to perform lifting operations in clear, calm weather conditions.
- Confirm that the crane and steel cables meet the requirements before proceeding with the lift.
- The doors of the equipment have all been closed and locked.
- Ensure the safe and reliable connection of steel cables.
- It is recommended to use a left-to-right or right-to-left lifting sequence to ensure a smooth lifting operation.

During lifting:

- Unauthorized personnel must not enter the lifting area, and no one should stand under the crane boom.
- Ensure the crane is positioned correctly and avoid long-distance lifting.
- Maintain stability, ensuring that the diagonal tilt of the cabinet does not exceed 5° .
- Ensure that the angle between the two cables does not exceed 90° .

- Lift and place the equipment gently. Lower the cabinet slowly and steadily to avoid impacting the internal components.
- When the cabinet contacts the base, wait until the load on the base is evenly distributed before removing the lifting cables.
- Do not drag wire ropes or lifting equipment, and avoid equipment collisions.
- Only proceed with lifting subsequent cabinets after the initial cabinet has been securely fixed.













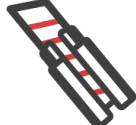

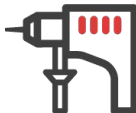



● Equipment installation

• Preparation before installation

Prepare tools:

- The illustrated tools are for reference only, please refer to the actual product.
- Due to varying site conditions, this tool list may not cover all possible tools. Installers and users should prepare any additional tools based on the actual situation.









Mounting tools:

			
Slotted insulated screwdriver	Phillips insulated screwdriver	Wire stripper	Diagonal pliers
			
Wire cutter	Art knife	Wrench	Rubber hammer
			
Electric hand drill	Cable drilling tool	Cutting machine	Tape
			
Levelling instrument	Vernier caliper	Steel ruler	Brush
			
Cable tie	Multimeter	Heat gun	Dust collector
			

Lifting cable	Insulation ladder	Forklift	Crane
---------------	-------------------	----------	-------

Diagram-Installation tool diagram

Personal protective tools:

 Insulating gloves	 Protective gloves	 Reflective vest	 Safety belt
 Insulated shoes	 Safety helmet	 Goggles	 Protective mask

Icon-Protective tool diagram

• Product installation

Operation steps:

- Step 1: Open the wooden box that contains the rack.
- Step 2: Take out the items in the box.
- Step 3: Use a forklift to move the rack to the installation location.

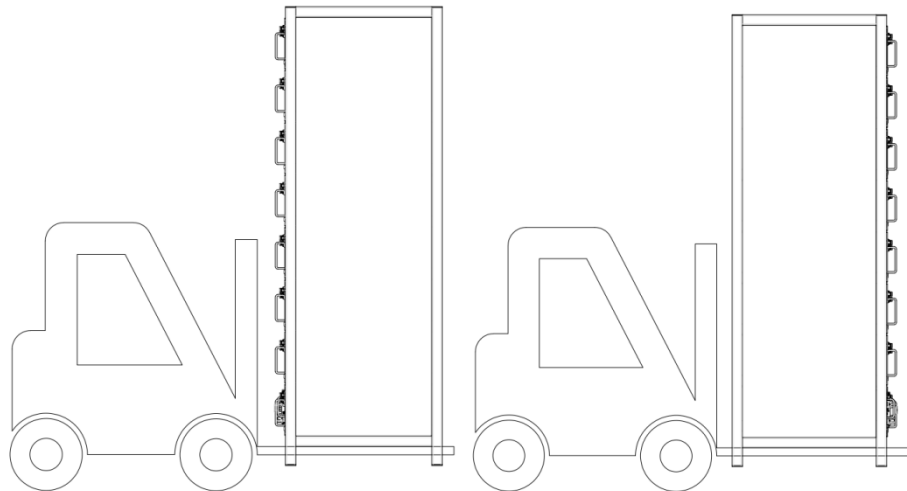

Note: Only work from the front and back is allowed.

- Step 4: Secure with bolts.

BOTTOM

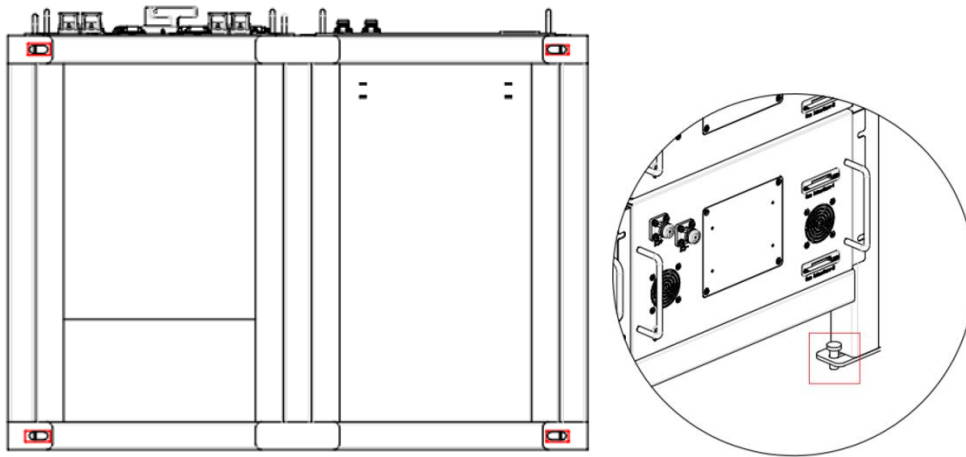

• **Battery Pack Installation**

Operation steps:

- Step 1: Open the wooden box containing the battery pack.
- Step 2: Take out the items in the box.
- Step 3: Use a forklift to place the battery pack into the rack in order.

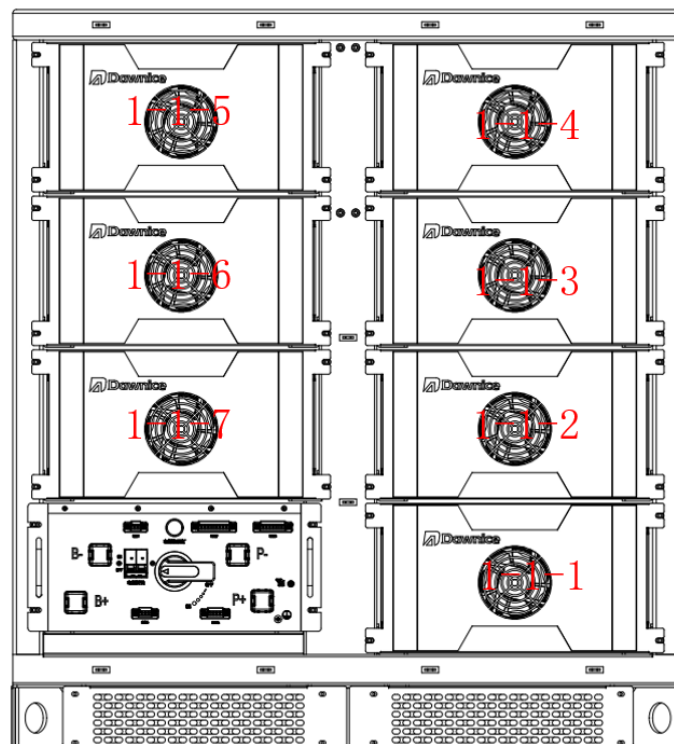
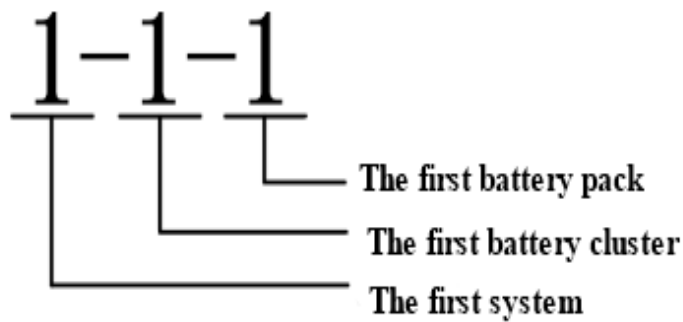
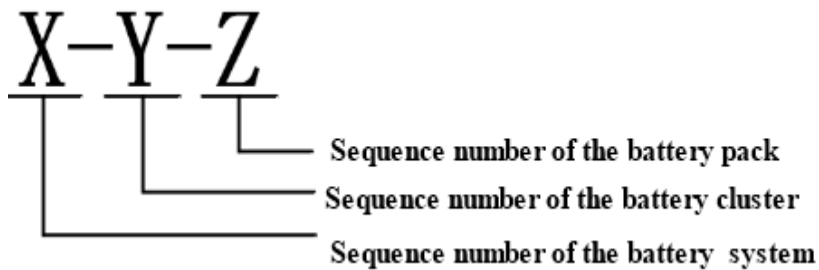

Figure 1. Battery pack installation sequence diagram

- Tag explanation:**



Installing Cables

- Prepare the cable**

Before installing cables, check the following accessories:

Name	Type	Conductor Cross-section	Source
Battery pack connecting line	Prefabricated DC cable (With bellows)	35mm ²	System configuration
Battery-cluster control box connecting line	Prefabricated DC cable (With bellows)	35mm ²	System configuration
Slave communication cable	RVSP Shielded twisted pair	0.75mm ² ; dual core	System configuration
Master-slave communication cable	RVSP Shielded twisted pair	0.75mm ² ; dual core	System configuration
PCS connect cable	Prefabricated DC cable	50mm ²	System

	(with corrugated tube)		configuration
PCS communication line	RVSP Shielded twisted pair	0.75mm ² ; dual core	System configuration

Installation Cable List

- Installation of battery cabinet cables**

There are five specifications of power cables provided with the box, namely A, B, AB, Total positive line, Total negative line. Connect them in sequence according to the diagram.

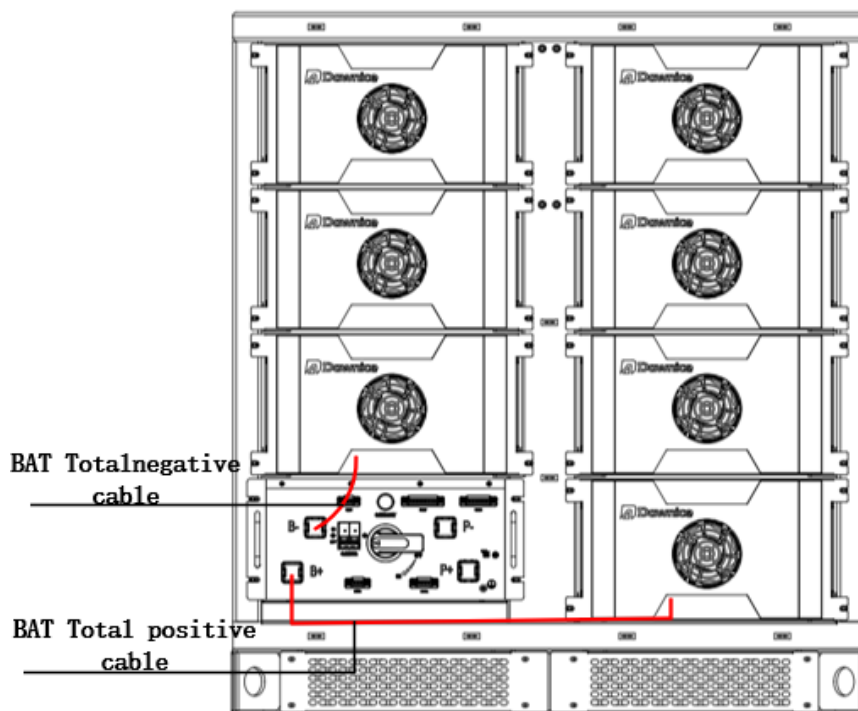

Battery cluster electrical cable installation diagram

- Battery Pack Communication Cable**

The battery pack communication cables provided with the box have three specifications: A, B, AB, and C. Connect them in sequence according to the diagram.

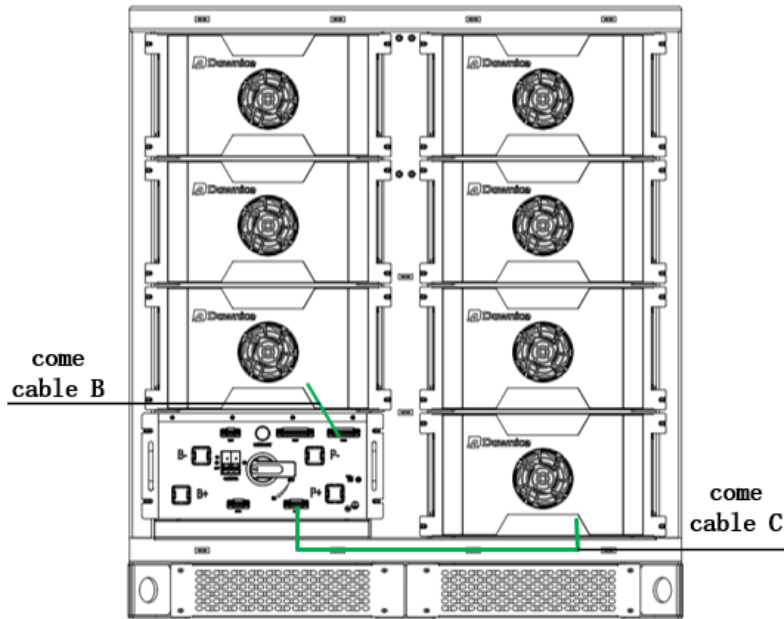

Battery cluster communication cable installation diagram

- **Installing External Connection Cables**

External electrical cables

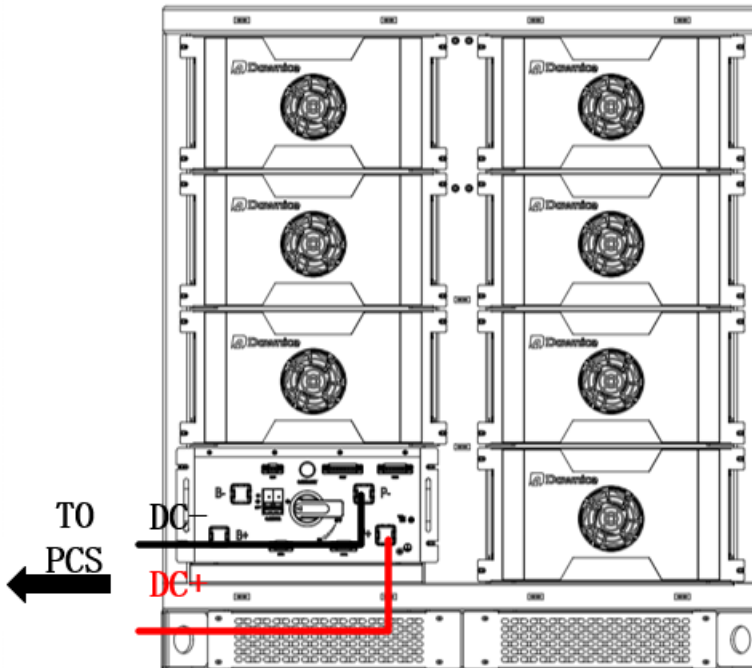

Figure Schematic diagram of battery cluster external electrical cable installation

- **External communication cables**

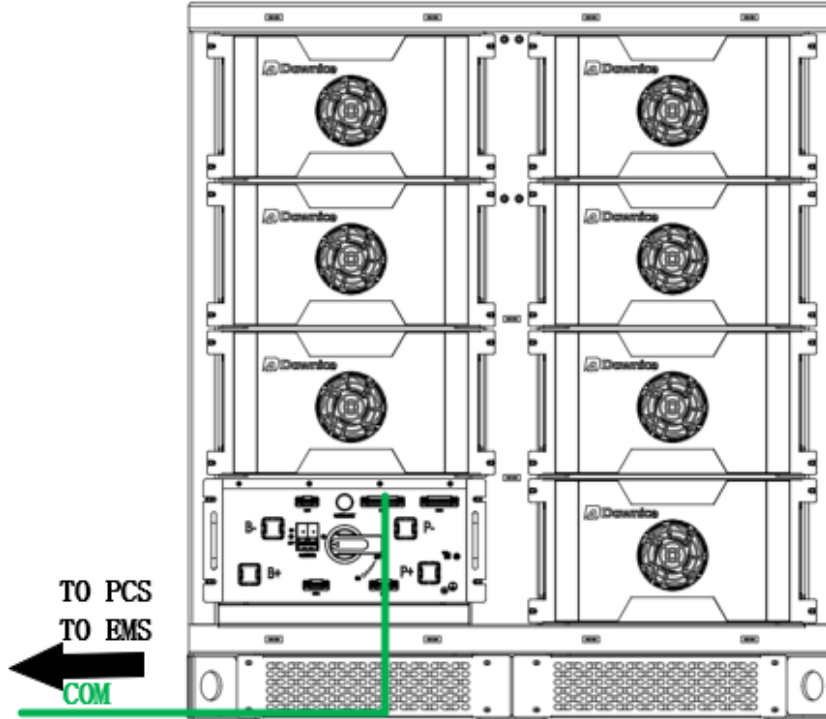

Figure Schematic diagram of battery cluster external communication cable installation

- **Fan power supply cable**

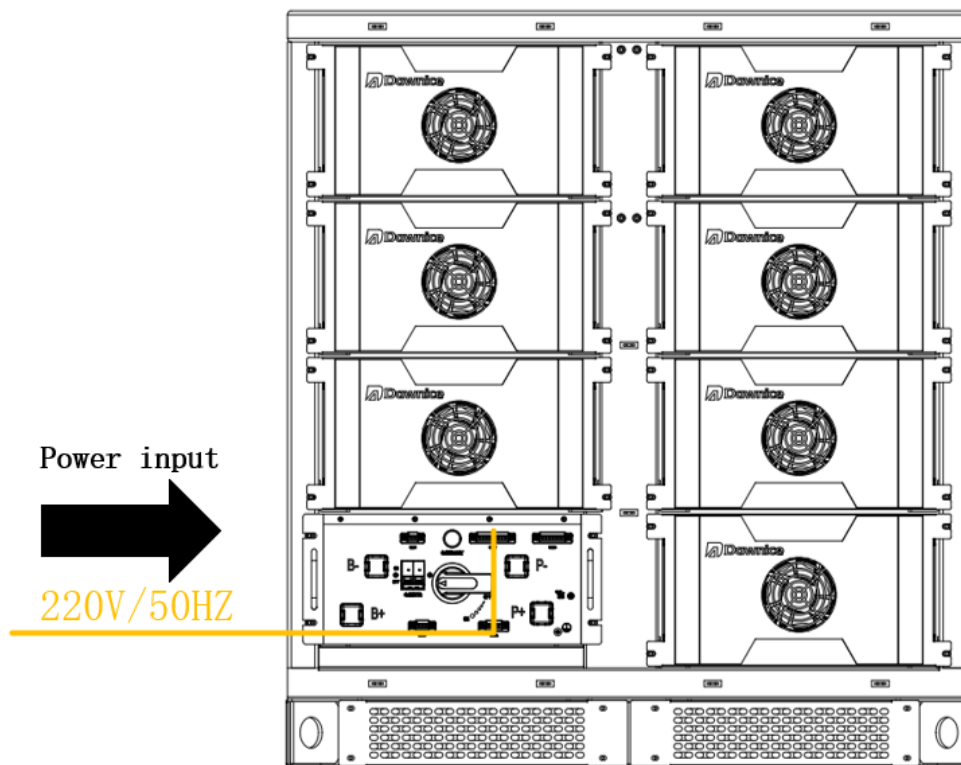

Figure Schematic diagram of battery cluster external power supply cable installation

● System power on

Note: This process is applicable for typical DC-side energy storage battery recommendations. For actual applications, please refer to the energy storage system operational requirements and local laws and regulations.

• Inspection before powering on

No.	Inspection Items	Inspection Contents
1	Equipment appearance	<ul style="list-style-type: none"> ➢ The equipment appearance is intact and undamaged. If there is paint peeling, please repair the paint. ➢ The equipment labels are clear and visible, and damaged labels should be replaced in time.
2	Cable appearance	<ul style="list-style-type: none"> ➢ The cable protection layer is wrapped intact without obvious damage. ➢ The conduit cable and hose are intact.
3	Cable connection	<ul style="list-style-type: none"> ➢ The cable connection position is the same as the design. ➢ The terminal production meets the specifications and the connection is

		firm and reliable.
4	Cable routing	<ul style="list-style-type: none"> ➤ Cut the wire buckle joints neatly without any exposed spikes or other phenomena. ➤ Leave a margin as required at the turning point and do not tighten it.
5	Switch	<ul style="list-style-type: none"> ➤ The external distribution cabinet switch is in the OFF state. ➤ The battery cluster switch is in the OFF state.

Table-Inspection contents before powering on

• **Power on procedures**

Steps	Item	Remark
1	Grid connected AC distribution cabinet power on	As shown in ①
2	AC distribution power on	As shown in ②
3	AC main switch of the energy storage system power on	As shown in ③
4	Power on the AC distribution box of the energy storage system	As shown in ④
5	Battery cluster DC circuit breaker power on	As shown in ⑤
6	Cluster control box auxiliary power supply power on	As shown in ⑥

Note: Before closing any switch, necessary safety checks should be conducted

Table-Power on procedures

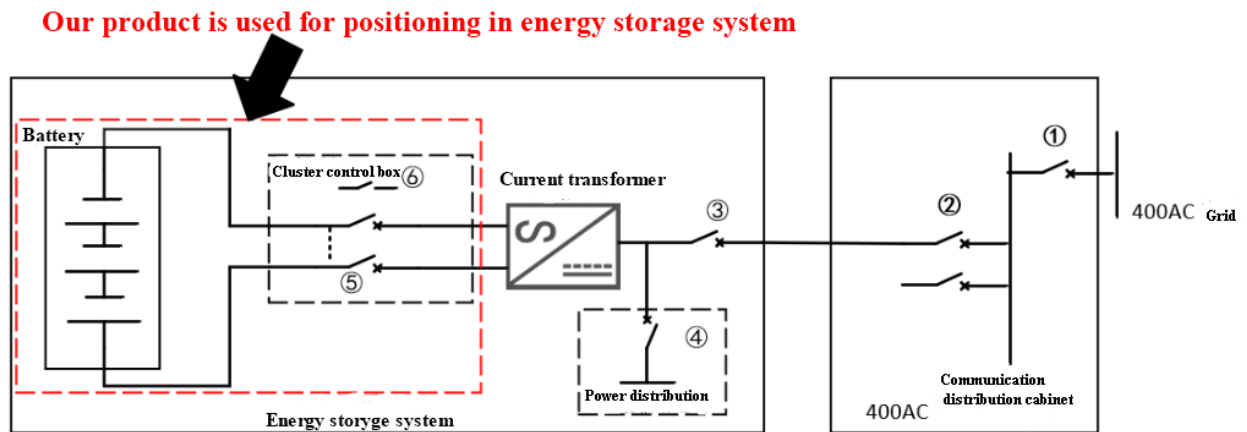

Figure-Power on procedures

• **AC-side power on**

Prerequisite requirements:

- The pre-power on inspection has been completed.
- The operator is wearing personal protective equipment.

- Confirm that the three-phase voltage is within the normal range before closing the circuit breaker.
- Confirm that the three-phase electrical phase sequence is correct before closing the circuit breaker.

Operating steps:

- Step 1: close the single-phase switch of the remote protection control system (if any).
- Step 2: close the remote three-phase switch.
- Step 3: measure the input voltage with a multimeter to ensure that it is within the normal operating voltage range.
- Step 4: close the single-phase switch of the near end protection control system (if any).
- Step 5: close the near end three-phase switch.
- Step 6: measure the output voltage with a multimeter to ensure that it is within the normal operating voltage range.

——End

- **DC-side power on**

Prerequisite requirements:

- 2 The pre-power on inspection has been completed.
- 3 The operator is wearing personal protective equipment.
- 4 Confirm that the AC main switch of the energy storage system is connected to the three-phase voltage within the normal range
- 5 Confirm that the AC main switch of the energy storage system is connected to the three-phase electrical phase sequence correctly
- 6 Confirm that the battery pack is connected correctly
- 7 Confirm that the battery pack, cluster control box, and inverter are connected correctly
- 8 Confirm that the power input/output protection cover of the cluster control box is securely closed

Operating steps:

- Step 1: Close the DC circuit breaker of the cluster control box
- Step 2: Open the DC circuit breaker of the cluster control box

——End

- **System power off**

- **Issue a stop work command**

Prerequisite requirements:

When the system is working normally, it is connected to the bus and operates with power

Operating steps:

- 2 Step 1: enter the command page of control devices such as PCS, inverters, EMS, etc.
- 3 Step 2: issue the "shutdown" command or control the system power to "0".
- 4 Step 3: enter the relevant device page and confirm that the system power is "0"; Confirm that the system has exited the charging and discharging state.
- 5 Step 4: use a clamp meter to measure and confirm that the system current is "0"

——End

- **Energy storage system power off**

Operating steps:

- 2 Step 1: disconnect the distribution switches of the energy storage system in sequence
- 3 Step 2: disconnect the AC main switch of the energy storage system
- 4 Step 3: disconnect the DC main switch of the energy storage system

——End

- **AC distribution power off**

Operating steps:

- 2 Step 1: disconnect the AC distribution switch
- 3 Step 2: disconnect the power distribution switch of the grid connection point

——End

- **System maintenance**

- **Maintenance instruction**

With the increase of service life and the influence of environmental temperature, humidity, dust, and vibration, the components inside the energy storage system will age, which will affect the performance of the energy storage system and even lead to malfunctions that cannot function properly.

Therefore, it is necessary to implement daily and regular maintenance on the energy storage system to ensure its normal operation and service life. All measures and methods that contribute to the good working condition of energy storage systems belong to the scope of maintenance work.

In case of fault, please contact our company. At the same time, provide the following information to provide you

with better service:

- Photos of the fault site.
- Model and serial number of the faulty product.
- Information on relevant components connected to the product.
- Installation and connection plan for energy storage system.
- Fault information and brief description.

- **Maintenance precautions**

Warning

Only personnel who have received relevant training and qualifications can perform maintenance operations on the energy storage system.



Note

When performing maintenance, avoid leaving metal items such as screws and washers inside the energy storage system to prevent potential damage to the system.

When servicing and maintaining the energy storage system, safety should be the top priority. To protect the operators, the following rules must be followed:

1. Disconnect the external connection of the energy storage system.
2. Ensure that the energy storage system is not accidentally powered on.
3. Before maintenance, use a multimeter to measure and ensure that the components being maintained are not electrified.
4. Ensure that the system is well grounded.

- **Maintenance work**

Maintenance Item	Maintenance Content	Recommended Period
Record keeping	Export data via USB and save backup.	One month
System inspection	Observe the appearance of the energy storage system for any damage, deformation, or rust. Observe various parameters during operation. Use a thermal imaging device or other detection system to monitor the heating situation. Check whether the ventilation, ambient temperature, humidity, dust and other environmental conditions around the inverter meet the requirements.	Three months
Air conditioning service	Check for dust. Use compressed air for cleaning. Replace the air filter screen.	Three months

Safety function	Check whether the emergency stop button is faulty. Check whether the command issuance function is faulty.	Six months
Identification inspection	Check the warning signs and other equipment identifications on the machine body. If they are found to be blurry or damaged, please replace them in time	Six months
Electrical connection	Check all electrical connections for looseness or poor contact. Check whether all cables and metal surfaces in contact with the skin are damaged or scratched. Check whether the insulation wrapping tape of all wiring terminals has fallen off Check for signs of overheating in the screw position. Check whether there is any color change in the wiring copper bars and screws.	Twelve month
Circuit breaker maintenance	Check the circuit breakers for failure. Check whether the circuit breaker or load switch is damaged.	Twelve month

Table-Maintenance work contents

Service E-mail: info@vesolenergy.com

Add.: Building 15, Economic Industrial Park, Yuanzhou Economic and Technological
Development Zone, Yuanzhou District, Yichun City, Jiangxi Province, China

Postcode: 336000

※※ The product information and parameters are subject to change without prior notice
