



User Manual

Energy Storage battery System

HZEB-LCT (Stacked)

Contents

1. Foreword	4
1.1 Applicable products	4
1.2 Applicable personnel	4
1.3 Legal statement	4
1.4 Revision history	5
2. Safety	6
2.1 Safety precautions	6
2.2 Safety measures	7
3. Product Introduction	9
3.1 Product characteristics	9
3.2 Product identification	10
3.3 Specifications and parameters	11
3.4 Appearance	12
3.4.1 Appearance of battery pack	12
3.4.2 Appearance of stacked	12
3.5 Description of control panel	13
4. Storage and Packaging	14
4.1 Inspection before signing for acceptance	14
4.2 Inspection of parts and components	14
4.3 Device storage	15
5. System Installation	16
5.1 Installation requirements	16
5.2 Installation	17
5.3 Wiring of single-battery system	18
5.3.1 Overview map of single-battery system wiring	18

5.3.2 Power line connection	19
6. System Operating	19
6.1 Inspection before powering on	19
6.2 Battery power-on	20
6.3 System operating topology	21
6.4 Battery power-off	21
7. Maintenance	22

1. Foreword

This Manual introduces the LCT series products of Yichun Vesol Manufacture and Trade Co., Ltd. (hereinafter referred to as the "Vesol"). HCT is a lithium iron phosphate (LFP) battery storage system. Please read this Manual before installing the battery and operate carefully in accordance with it during installation. If you have any questions, please contact Vesol for advice and explanations.

1.1 Applicable products

This Manual applies to the following model:

HZEB-LCT-35(5kW*h)

HZEB-LCT-40(5kW*h)

HZEB-LCT-45(5kW*h)

HZEB-LCT-50(5kW*h)

HZEB-LCT-55(5kW*h)

HZEB-LCT-60(5kW*h)

1.2 Applicable personnel

This Manual is only applicable to the professionals who are familiar with local regulations, standards, and electrical systems, have received professional training, and are familiar with the relevant knowledge of this product.

1.3 Legal statement

The copyright of this Manual belongs to Vesol. Without the prior written

authorization of Vesol, no part of this Manual may be extracted, duplicated, translated, annotated or copied in any form or manner.

All rights reserved by Vesol. This product meets the design requirements for basic environmental protection and personal safety. The product shall be stored, used, and disposed of in accordance with the product manual, relevant contracts or relevant laws and regulations.

Please note that our company may make modifications to contents of this Manual without prior notice. If any changes are made to its information, we will not notify you separately.

1.4 Revision history

The latest version in the "Revision history" contains updates from all previous versions of this Manual.

V1.0.0.20241017

- First issue

2. Safety

2.1 Safety precautions

Before proceeding with any work, please read all safety instructions carefully and follow them when operating the battery.

Incorrect operation may result in:

- Injury or death of operators or third parties.
- Damage to the system hardware.

Skills that qualified personnel shall have:

- Training in installation, debugging, and hazard handling of electrical system.
- Understanding of this Manual and other related documents.
- Understanding of local regulations and directives.

Following symbols are used in this Manual to highlight important information:



Warning: Indicates a dangerous situation. If not avoided, it may lead to death or serious injury.



Caution: Indicates possible damage or injury. If not avoided, it may result in minor injury or property damage.



Notice: Indicates that there may be a risk of damage to the product.

2.2 Safety measures

Tips

1. It is very important and necessary to read this User's Manual carefully before installing or using the battery. Failure to follow any instructions or warnings in this Manual may result in electric shock, serious injury, or death, or may damage the battery, causing it to fail. Damage caused by improper operations mentioned above is not covered under the warranty of this product.
2. If the battery is to be stored for a long time, it needs to be recharged every six months to a SOC level not less than 90%.
3. The battery shall be recharged within 12 hours after complete discharge.
4. The power terminals must not be connected in reverse.
5. All battery power terminals must be disconnected during maintenance.
6. In case of any abnormality, please contact the supplier within 24 hours.
7. Do not clean the battery with any detergents.
8. Do not expose the battery to flammable or irritating chemicals or vapors.
9. Do not directly connect the battery to the photovoltaic solar line.
10. Never insert any foreign object into any part of the battery.
11. The direct or indirect damage due to above reasons are not covered under the warranty.

Warning

Before connecting:

1. Please check the product and packing list after unpacking. If the product is damaged or any part is missed, please contact your local dealer.

2. Before installation, please make sure to cut off mains supply and ensure that the battery is turned off.
3. Make sure that the wiring is correct, do not mistake positive and negative terminals of the cable, and ensure that no short circuit is caused to any external device.
4. Never connect the battery directly with the AC power supply.
5. Do not connect the battery in series as the embedded BMS in the battery is of 51.2 V DC design.
6. The battery must be grounded in a way that the resistance is less than 0.10 MΩ.
7. Please ensure that electrical parameters of the battery system are compatible with the relevant devices.
8. Please keep the battery away from water and fire sources.

Notice

During use:

1. If it is necessary to move or repair the battery system, be sure to cut off the power and completely turn off the battery.
2. Never connect the battery with other different types of batteries.
3. Never connect the battery with a faulty or incompatible inverter.
4. Never disassemble the battery.
5. Do not open, repair, or disassemble the battery, except for staff or authorized personnel. Our company shall not be liable for any consequences or related liabilities arising from violations of safety operations or design, production, and safety standards of equipment.
6. Never connect this product with other models in parallel.

3. Product Introduction

HZEB-HCT is the latest high-voltage DC energy storage system product (hereinafter referred to as "this product") developed by Yichun Vesol Manufacture and Trade Co., Ltd., which can provide reliable power support for residential buildings and is a good partner for environmentally friendly living.





This product needs to be used with a high-voltage inverter, which can be compatible with mainstream brand inverters on the market.

3.1 Product characteristics





This system has following functional characteristics:

1. High voltage accuracy (≤ 20 mV)
2. High current accuracy ($\leq 2\%$ @FS)
3. Short-circuit protection
4. Adjustable over-current protection
5. Adjustable parameter settings
6. LED indication of product status
7. Charging equilibrium
8. Self-cooling mode (both noise and power consumption of the system itself are reduced significantly)

3.2 Product identification

 Energy Storage Battery Cluster	
Model:HZEB-LCT-5-HD60	Cell Type:LiFePo4
Rated voltage:DC614.4V	Voltage range:537.6V-691.2V
Energy:61.44kW-h	Capacity:100Ah
Recharging current:<50A	Discharge current:<50A
Working humidity:0~90% (non-condensing)	
BAT Working temperature:0℃~+55℃ (>45℃reduce power)	
Protection Level:IP20	
Date of manufacture:2024.9.11	
Manufacturer:Jiangxi Hertz New Energy Technology Co.,Ltd	
Supplier :Yichun Dawnice Manufacture and Trade Co.,Ltd	
Made in China	
  	

Interpretation of labels

-  Do not place near open flames or in the fire
-  Do not place in a damp environment
-  Do not dispose of discarded batteries in the trash can and have them recycled by professionals or organizations
-  MSDS material inspection certification mark
-  Dangerous goods transportation certification mark

3.3 Specifications and parameters

Model	HZEB-LCT-35	HZEB-LCT-40	HZEB-LCT-45	HZEB-LCT-50	HZEB-LCT-55	HZEB-LCT-60
Cell type	LPF	LPF	LPF	LPF	LPF	LPF
Rated power (kW.h)	35.84	40.96	46.08	51.2	56.32	61.44
Rated voltage (VDC)	358.4	409.6	460.8	512	563.2	614.4
Working voltage (VDC)	313.6-403.2	358.4-460.8	403.2-518.4	448-576	492.8-633.6	537.6-691.2
Rated capacity (Ah)	50A (0.5C)	50A (0.5C)	50A (0.5C)	50A (0.5C)	50A (0.5C)	50A (0.5C)
System specification						
Size (Left)	680*420*795	680*420*975	680*420*975	680*420*1155	680*420*1155	680*420*1335
Size (Right)	680*420*845	680*420*845	680*420*1025	680*420*1025	680*420*1205	680*420*1205
Battery weight	≤456kg	≤513kg	≤570kg	≤627kg	≤684kg	≤741kg
Discharge temperature range	-10°C~55°C	-10°C~55°C	-10°C~55°C	-10°C~55°C	-10°C~55°C	-10°C~55°C
Temperature range	5%~90%	5%~90%	5%~90%	5%~90%	5%~90%	5%~90%
Altitude	≤2000m	≤2000m	≤2000m	≤2000m	≤2000m	≤2000m
Cooling method	Self cooling	Self cooling	Self cooling	Self cooling	Self cooling	Self cooling
Communication mode	RS485/CAN	RS485/CAN	RS485/CAN	RS485/CAN	RS485/CAN	RS485/CAN

3.4 Appearance

3.4.1 Appearance of battery pack

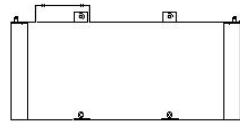
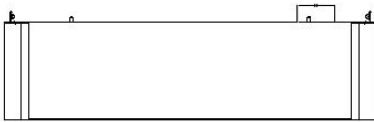
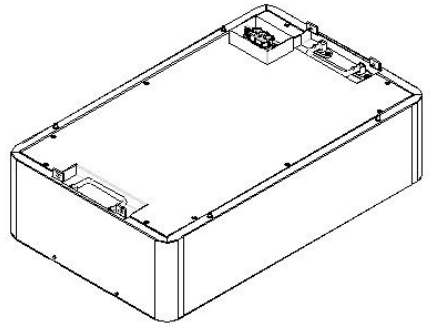
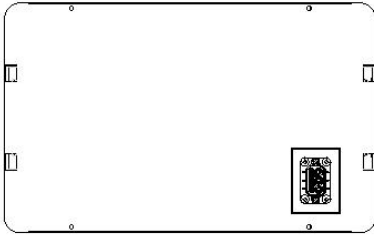

3.4.2 Appearance of stacked

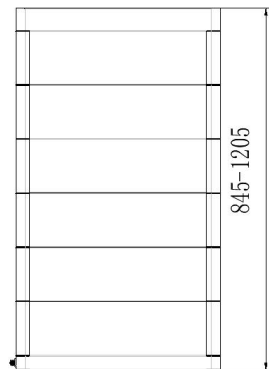
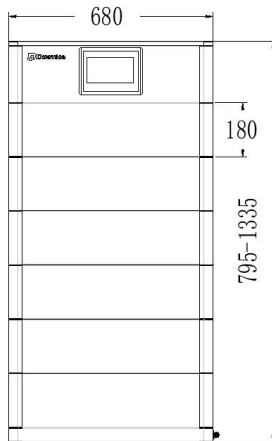
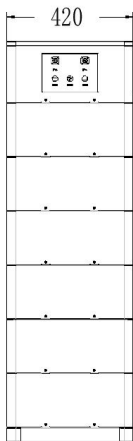

3.5 Description of control panel

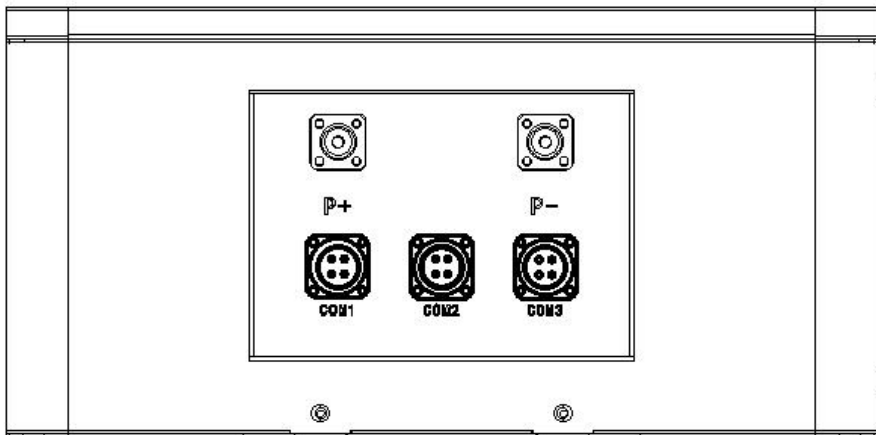

Power Input/Output Port Definition:

Interface Definition	Feature description	Remark
P+	PCS Input positive terminal	Connect the positive end of PCS, the interface is M8 bolt
P-	PCS Input negative terminal	Connect the negative end of PCS, the interface is M8 bolt

Port Definition:

Item	COM port	Definition	Function description
1	COM1(4P)	CAN1H	Isolate CAN (With PCS or external equipment)
2		CAN1L	
3		485A1	Isolate 485 (With PCS or external equipment)
4		485B1	
1	COM2(4P)	CAN0H	Debugging CAN
2		CAN0L	
3		-	-
4		-	-
1	COM3(4P)	CAN1H	Isolate CAN

2		CANIL	(With PCS or external equipment)
3		NC	-
4		NC	-

4. Storage and Packaging

4.1 Inspection before signing for acceptance

Before signing for this product, please check it carefully as follows:

1. Check the outer packaging for any damage, such as deformation, holes, cracks or other signs that may cause damage to the device inside the packaging box. If there is any damage, please contact your dealer without opening the package.
2. Check whether the device model is correct. If there is any discrepancy, please contact your dealer without opening the package.
3. Check whether the type and quantity of the delivered parts are correct and whether there is any damage in appearance. If there is any damage, please contact your dealer.

4.2 Inspection of parts and components

Before installing this product, please check the following parts and components carefully:

1. Battery
2. External power cable
3. Communication harness
4. Manual
5. Battery base
6. Connect the wiring harness between the batteries

4.3 Device storage

If the device will not be immediately put into operation, please store it according to the following requirements:

1. Make sure that the outer packaging box is not removed and that the desiccant inside the box is not lost.
2. It is recommended to complete installation of the device within 3 days after removing the packaging box. If the device is not installed, it shall be repackaged in the original packaging box for storage.
3. Keep away from flammable, explosive, and corrosive environments and items during storage.
4. Be sure to store it in a cool and shaded place, and avoid direct sunlight.
5. Recommended SOC range during storage: 30%–60%. A charge-discharge cycle shall be carried out every 3 months.
6. Storage temperature range:
 - When $-20^{\circ}\text{C} \leq$ the temperature $< 10^{\circ}\text{C}$, the storage time shall not exceed 1 month.
 - When $10^{\circ}\text{C} \leq$ the temperature $\leq 35^{\circ}\text{C}$, the storage time shall not exceed 1 year.
 - When $35^{\circ}\text{C} <$ the temperature $\leq 55^{\circ}\text{C}$, the storage time shall not exceed 1 month.
7. Storage humidity range: 0%–90% RH without condensation. If any moisture or condensation is found at the battery interface, the battery system shall not be installed.

5. System Installation

5.1 Installation requirements

Installation environment requirements:

1. The device shall not be installed in flammable, explosive, or corrosive environments.
2. The device shall be installed at a location that is far away from water pipes and cables inside the walls to avoid dangers during drilling.
3. The installation environment shall avoid direct sunlight, rain, snow accumulation, etc. It is recommended to install in a sheltered location. If necessary, a sunshade can be built.
4. The installation space must meet the ventilation and heat dissipation requirements of the device and the operation space requirements.
5. The device shall have a protection level that meets the requirements for indoor installation, and the temperature and humidity of the installation environment shall be kept within their respective appropriate ranges.
6. The installation height of the device shall facilitate operation and maintenance, ensuring that the device's indicators and labels are easily visible and that the terminal connectors are easily accessible.
7. The device shall be installed at an altitude below 2,000 m (the highest working altitude).
8. The device shall be kept away from strong magnetic field environments to avoid electromagnetic interference. If the installation location is close to a radio station or wireless communication device below 30 MHz, make sure that the battery is kept 30 m away from such device that generates wireless electromagnetic interference.

5.2 Installation



Note: The battery installation shall be performed by two people

Step 1 Remove the items that come with the box

Step 2 Place the battery base on the ground

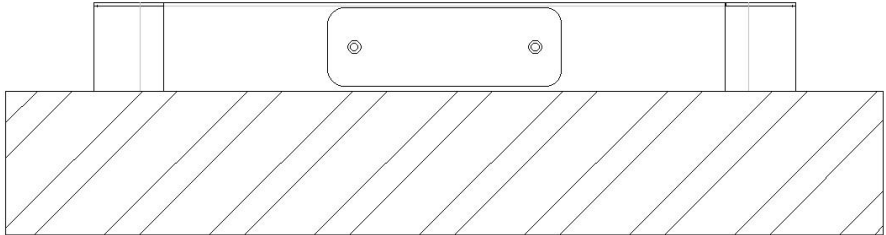

Step 3 Grasp the carry handle and align the battery to the bulge on the base stacked on the base

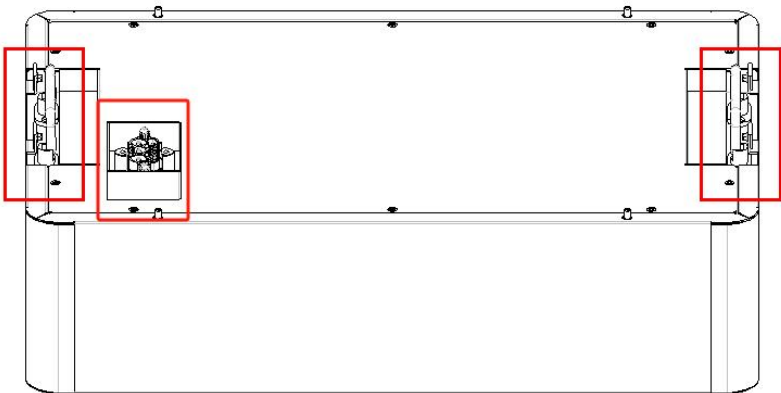

Step 4 The installation sequence is shown in the image

Left: A base - 1-1-X battery box (numbered from large to small) - HVBOX

Right: Base B - 1-2-X battery box (numbered from largest to smallest) - cover

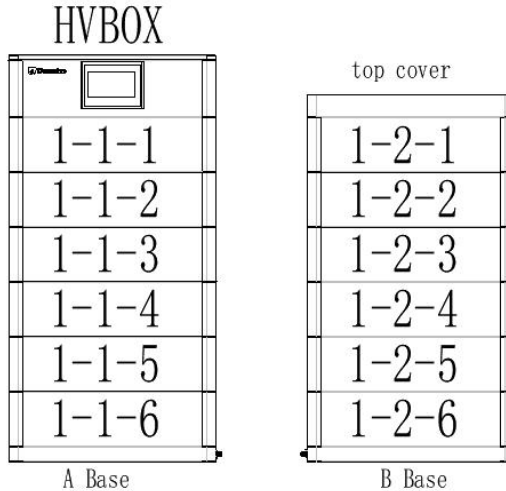

5.3 Wiring of single-battery system

5.3.1 Power cables

There are two specifications of power cables that come with the box, namely P+ and P-

Follow the diagram to make the connection

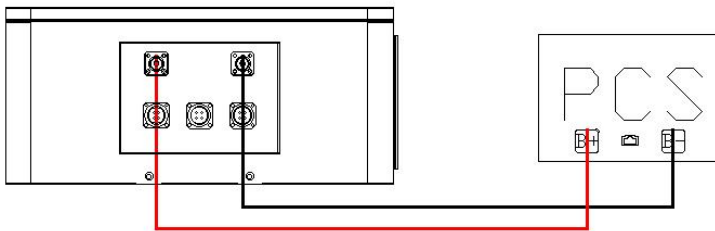

5.3.2 Power line connection

There is a specification of the communication cable that comes with the battery pack, the air plug terminal is plugged into the COM1 port of the HVBOX, and the RJ45 terminal is plugged into the BMS port of the inverter

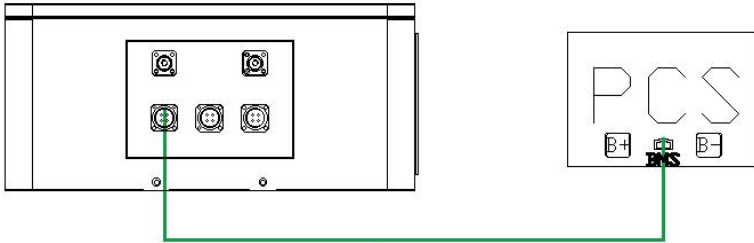

6. System Operating

6.1 Inspection before powering on

Before the battery system is powered on, be sure to check it according to the following requirements to prevent any damage to the system.

1. The inverter shall be installed firmly at a position that is easy to operate and maintain, a space that is conducive for ventilation and heat dissipation, and a clean and tidy environment.
2. The power lines and communication lines shall be connected correctly and firmly.
3. The cables shall be tied in a way that the routing requirements are met, distribution is reasonable, and no damage will be caused.

6.2 Battery power-on



Note: The circuit breakers between inverter and battery and between batteries shall be installed according to local laws and regulations.

Step 1 Close the battery circuit breaker.

Step 2 Press the battery button switch.

Step 3 Close the circuit breaker between the battery and the inverter. (Optional)

Step 4 Power on the inverters used in the system. For detailed operation, please refer to the user's manual of the inverter of corresponding model.

Step 5 Close the air switch of the load.

6.3 System operating topology

Single-battery system:

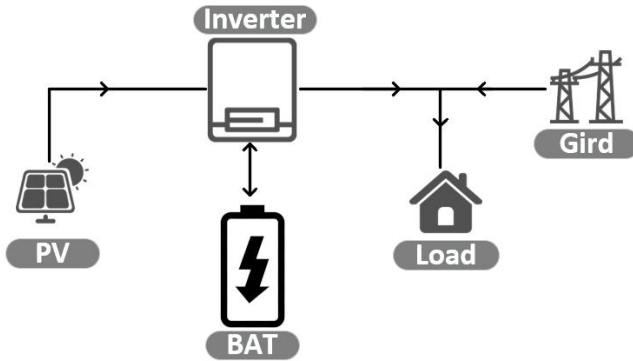

6.4 Battery power-off

To power off the battery system, please follow the following steps:

- Step 1 Press the button switch
- Step 2 Make sure that the indicator is off
- Step 3 Disconnect the battery circuit breaker
- Step 4 Disconnect the distribution circuit breaker

7. Maintenance

Maintenance Item	Maintenance Interval
If the battery is not put into use, it shall be fully charged and then discharged to 30%–60%.	Once every 3 months
Check whether the wall mount bracket is installed loose. If so, please tighten the corresponding position.	Once every 6 months
Check whether the case is damaged. If so, please repair the paint or contact for after-sales service.	Once every 6 months
Check the exposed cables for wear. If wear is found, replace the corresponding cable or contact for after-sales service.	Once every 6 months
Check whether any debris piled up around the battery. If any, please clean it to avoid heat dissipation of the battery from being affected.	Once every 6 months
Check whether any water or pests enter into the battery to avoid the battery from being invaded for a long period of time.	Once every 6 months



Warning:

- If any problems are found to have an impact on the battery or the battery and energy storage inverter system, please contact our after-sales personnel, and do not disassemble it without authorization; any damage caused by unauthorized disassembly shall be borne by the disassembling party.
- If the copper conductor inside any conductive wire is found to be exposed, do not touch it as the high voltage is dangerous, please contact our after-sales personnel, and do not disassemble it without authorization.
- In case of other emergencies, please contact our after-sales personnel at the first time, and operate by professionals under the guidance of our after-sales personnel.



Yichun Vesol Manufacture and Trade Co., Ltd.

Add.: Building 15, Economic Industrial Park, Yuanzhou Economic and
Technological Development Zone, Yuanzhou District, Yichun City, Jiangxi
Province, China

Postcode: 336000

※ The product information and parameters are subject to change without prior notice